

Tools for crimping terminals and connectors in Chapters 4, 5 and 7

Tools for Cu-terminals 4 - 120 mm ²	3
Battery powered crimp tool for Cu terminals 10 - 95 mm ²	4
Tools for Cu-terminals, Al-terminals and C-sleeves 6 - 50 mm ²	5
System 800	8
SYSTEM 1300	12
SYSTEM 1300 C-type crimp head	18
DUAL Crimp System	21
SYSTEM V250	23
SYSTEM 1400	28
SYSTEM 1470	35
Hydraulic foot pump, P4000	37
Battery and mains powered pump, PS700	38



Hydraulic crimp systems

Elpress hydraulic crimp systems fit Elpress terminals and connectors from 10 to 1200 mm². The systems are constituted by either pumps and crimp heads which can be freely combined or by complete hand held tools where these functions are intergrated. For crimping, pre-rounding of sectorised conductors, cable cutting, etc. there are a variety of accessories. Together with matching terminals the complete crimp system is formed. Both pumps and manual tools have, with a few exceptions, fast feed function that allows the actual crimping to start after the dies have rapidly been brought in contact with the terminal. There is also a full-closure function to safe-guard a complete crimp action. To meet special ergonomic requirements Elpress has also developed crimp heads made from titanium - a material with about half the specific weight of steel. The standard pumps are used and the system makes work in difficult environments considerably more comfortable.

The PS700 is a new example of innovative thinking, where there is a free choice between 230VAC mains or 24 VDC battery powered operation combined with advanced monitoring and control features, see page 9:38.



PS700 with crimp head V1300.

V1300 - system

Cu

Crimping of Cu-terminals 10-400 mm². The V1300-system is also available in a C-version with an open head for crimping of Cu-terminals, see page 9:18.

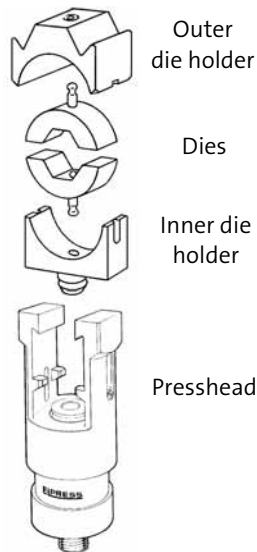

Al

Crimping of Al-terminals and preforming of Al-conductors 16-240 mm². Preforming is done on sector-shaped Al-conductors.

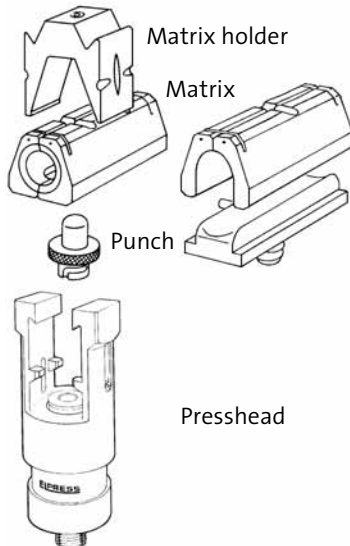

V1400 - system

Cu

Crimping of Cu-terminals 10-500 mm².

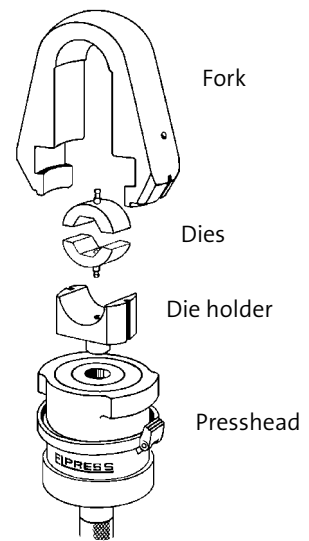

Al

Crimping of Al-terminals and preforming of Al-conductors 16-630 mm². Preforming is done on sector-shaped Al-conductors.

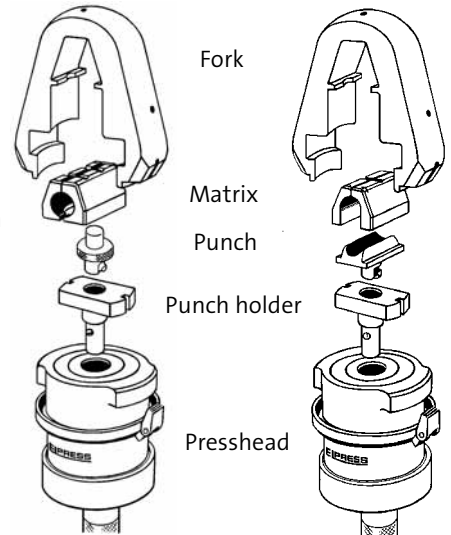



Tools for Cu-terminals 4 - 120 mm²

Crimp range 4 - 25 mm²

T2258 and T2288

T2258/T2288



Crimp types



Elpress crimp tool for crimping of Cu-terminals and connectors:
T2258: KR/KRF/KS/KSF, 4-16 mm² and KR/KRD/KSD, 4-25 mm²
T2288: KR/KRT/KS/KST, 10-25 mm²

Note that the earlier tool T2287 is now integrated into T2258, which therefore may be used also for KRD/KSD types.

Particulars:

- equipped with full closure ratchet mechanism
- weight 0,60 kg, length 300 mm

Crimp range 10 - 70/95 mm²

T3165A1/T3165B/T3165C

T3165A1/T3165B/T3165C



Crimp type



Elpress crimp tool for crimping of Cu terminals and connectors:
T3165A1: KR/KRF/KS/KSF, 10-70 mm².
T3165B: KR/KRD/KS/KSD, 10-95 mm².
T3165C: KRT/KST, 10-95 mm².

Particulars:

- equipped with full closure mechanism
- crimp wheel of rolled steel which gives high durability
- weight 3,0 kg, length 500 mm
- crimp force up to approximately 35 kN

Crimp range 6 - 50 mm²

TH0650T

TH0650T



Crimp type

Mechanical handtool for crimping of Cu-terminals type KRT/KST up to 50 mm².

Particulars:

- rotating crimp wheel
- weight 1,5 kg, length 400 mm
- no full closure mechanism

Crimp range 10 - 120 mm²

TH10120T

TH120T



Crimp type

Mechanical handtool for crimping of Cu-terminals type KRT/KST up to 120 mm².

Particulars:

- rotating crimp wheel
- weight 3,7 kg, length 650 mm
- no full closure mechanism



Battery powered crimp tool for Cu terminals and connectors 10 - 95 mm²

Crimp range 10 - 95 mm²

PV350 - Elpress Mini

PV350

Battery powered crimp tool for crimping of Cu terminals and connectors up to 95 mm². Separate, special dies to be used in accordance with table below.



Particulars:

- hexagonal crimping up to 120 mm²
- easy-to-open crimp head for rapid die change
- slim ergonomic design - good accessibility even in confined areas
- NiCd batteries (9.6 V, 1,3 Ah), charge time approx. 40 minutes
- rapid crimp operation 2-4 seconds
- approx. 100 - 150 crimps per battery charge (depending on temperature, frequency, etc.)
- weight 1.6 kg, length 360 mm
- dies for crimping special through connectors for service and road lightning cables, System 0616

9

Crimp type



Crimp dies for PV350

Supplied in pairs.

For hexagonal crimping of copper terminals and connectors



Die pairs ME0616 and MB 11 for PV350.

mm ²	For KR/KRF KS/KSF		For KR/KRD KS/KSD		For KRT/KST	
	Die No.	No. of crimps	Die No.	No. of crimps	Die No.	No. of crimps
10; (KR/KS types)	MB8	1	MB8	1	MB7	1
16	MB9	1	MB8	1	MB8.5	1
25	MB11	2	MB9	1	MB10	2
35	MB13	2	MB11	2	MB12	2
50	MB14,5	2	MB12	2	MB14	3
70	MB17	3	MB14	3	MB16	3
95			MB17	3		
	System 0616					
6 - 16	ME0616	1				



Tools for Cu-terminals 10 - 240 mm², Al-terminals 16- 25 mm² (-35 solid) mm² and C-sleeves 6 - 50 mm²

T2600/T2600B/T2600C



Crimp types



T2600/T2600B/T2600C

Mechanical handtool for crimping of Cu- and Al-terminals: T2600 for KRF/KSF, T2600B for KRD/KSD, T2600C for KRT/KST.

Particulars:

- rapid opening enables easy die change and quick removal after jointing
- crimp die (TB7) is available for solid 10 mm² Cu-connector, (for EXCL-type cable or similar)
- crimp force up to 57 kN
- supplied in a metal box
- rapid die closure and minimum handle force
- easy to operate in confined spaces
- only four dies are required to crimp 10 - 120 mm² Cu (KRD/KRT)
- rapid feed function
- weight 1,9 kg, length 440 mm, width 140 mm

V611



Crimp types



V611

Hydraulic tool for crimping of Cu terminals and connectors up to 240 mm², using the same dies as T2600 and PV611.

Particulars:

- two-step, fast feed piston movement to crimp engagement which makes the crimp cycle shorter
- the crimp range reaches up to 150 mm² (KRF), 185 mm² (KRD), 240 mm² (KRT) and 50+50+ mm² (C-sleeves)
- same crimp dies as for PV611, i.e. TB- and KB-types
- weight 2,5 kg, dimensions 425 x 115 x 53 mm
- crimp force 60 kN
- supplied in a robust textile bag with foam rubber insert

PV611



Crimp types



PV611

Battery tool with large crimp range, up to 240 mm², using same dies as T2600 and V611.

Particulars:

- crimps Cu-terminals up to KRF 150 mm², KRD 185 mm², KRT 240 mm² and C-sleeves up to 50/50 mm²
- supplied in robust metal box, battery with charger and instructions
- number of crimps is normally > 100 depending on size and temperature
- crimp time 5 - 8 s depending on size
- battery type NiMH 12 V, 2.6 Ah
- LED to indicate tool and charge status
- weight 4.5 incl. battery



Accessories for tool types T2600, V611 and PV611

- Note that KRF terminals may be used on flexible (IEC60228, class 5) as well as stranded (class 2) conductors and that KRD and KRT terminals are used on stranded conductors.
- Be sure to use dies exactly matching the terminal.

Crimp dies

Supplied as a pair.

For hexagonal crimping of Cu terminals and connectors.

Note: KB dies are for V611 and PV611 only.



TB dies.



KB dies.

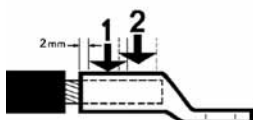
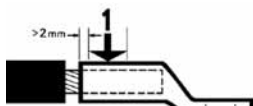

Two crimps.

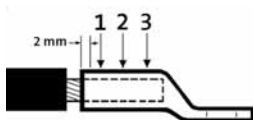

Three crimps.

KRF/KSF		
mm ²	Dies	No. of crimps
10 and 70	TB8-17	1 resp.2
16 and 35	TB9-13	1
25 and 50	TB11-14,5	1
10 and 95	TB ¹ -20	1 resp.2
120	KB22	3
150	KB25	3

KRD/KSD		
mm ²	Dies	No. of crimps
10 ² /16 and 70	TB8-14	1
25 and 50	TB9-12	1
35 and 95	TB11-16	1 resp.2
10 ¹ and 120	TB7 ¹ -19	1 resp.2
150	KB22	3
185	KB25	3

¹ TB7 special for crimping KRX-terminals and KSX-connectors

² For terminals type KR10 and connectors type KS10

KRT/KST		
mm ²	Dies	No. of crimps
10 ¹ and 120	TB7-19	1 resp.2
10 ² and 95	TB8-18	1 resp.2
16 and 95	TB8,5-18	1 resp.2
25 and 70	TB10-16	1 resp.2
35 and 50	TB12-14	1
150	KB22	3
185	KB24	3
240	KB26	3

¹ TB7 is also for crimping KRX-terminals and KSX-connectors

² For terminals type KR10 and connectors type KS10

DIN 46235		
mm ²	Dies	No. of crimps
10-16	TB6-8DIN	1
25-35	TB10-12DIN	1
50-70	TB14-16DIN	1 resp.2
95	TB18DIN	1 resp.2



TBNP dies.

For **overhead line connectors** for alloy Al conductors, hexagonal crimping.

mm ²	Dies	No. of crimps
31-99	TBNP16-20	Die side 16: 2x5 Die side 20: 2x10



TBC dies.

For Cu, branch connectors (C-sleeves), oval crimping.

Dies	Main conductor mm ²	Branch mm ²	Crimp in die nest	No. of crimps
TBC4-C8-9	10-6	10-6	TBC4*	1
	50-16	50-16	TBC8-9	2
TBC5-C6	16-10	16-6	TBC5	1
	25-16	25-16	TBC6	1

* Die nest marked C4A to be used for 6 mm² main to 6 mm² branch.

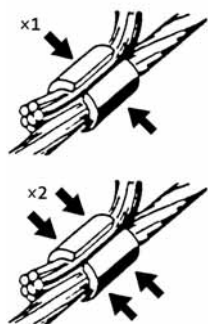

One resp. two crimps.

Punch and matrix

For Al terminals and connectors, indent crimping.

Stranded mm ²	Solid mm ²	Matrix holder	Matrix	Punch
16-25	16-35	TV2620	TP13M	TP13D



Matrix holder TV2600, matrix TP13M and punch TP13D.



Always crimp twice on Al.



System 800 for crimping Cu 10 - 240 mm² and Al 16 - 150 (-185 solid) mm²

V800



Crimp types



V800

Steel crimp head to be powered by Elpress foot pump P4000 or the battery/mains powered electro-hydraulic pump PS700.

Particulars:

- special nitrogen anti-corrosion surface treatment on hardened steel
- equipped with oil spray safety protection cap
- weight 3,4 kg, excl. accessories
- working pressure 63 MPa (630 bar)
- length 266 mm, incl. quick coupling
- width 94 mm (widest part)
- crimp force 80 kN
- equipped with "holding dies", i.e. the dies are spring loaded to hold the connector in location prior to crimping
- very easy to operate
- matched with Elpress pumps and connector elements
- in most cases the same dies, matrices and punches as for the V1300 and V1400-systems are used; in some cases, however, the dies are special (prefix "8")



Accessories for crimping Cu and overhead lines with V800

Crimp dies

Supplied as a pair.

For hexagonal Cu-crimping of copper terminals and connectors up to

- 185 mm² KRF/KSF
- 240 mm² KRT/KST and KRD/KSD

Die holder **V816** is used for all dies below.



B-dies, die holder V816.

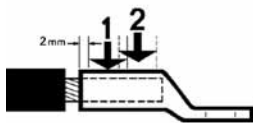
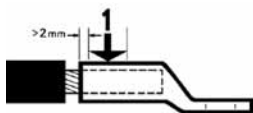

Two crimps.

KRF/KSF		
mm ²	Dies	No. of crimps
10	B8	1
16	B9	1
25	B11	1
35	B13	1
50	B14,5	1
70	B17	1
95	8B20	2
120	8B22	2
150	8B25	2
185	8B27	2

KRD/KSD		
mm ²	Dies	No. of crimps
10	B8	1
16	B8	1
25	B9	1
35	B11	1
50	B12	1
70	B14	1
95	B16	1
120	8B19	2
150	8B22	2
185	8B25	2
240	8B27	2

KRT/KST		
mm ²	Dies	No. of crimps
10	B7	1
16	B8.5	1
25	B10	1
35	B12	1
50	B14	1
70	B16	1
95	8B18	2
120	8B19	2
150	8B22	2
185	8B24	2
240	8B26	2





DIN 46235 terminals		
mm ²	Dies	No. of crimps
10	B6DIN	1
16	B8DIN	1
25	B10DIN	1
35	B12DIN	1
50	B14DIN	1
70	B16DIN	1
95	8B18DIN	2
120	8B20DIN	2

Hexagonal crimping for over head AC connectors.
Dies without the pins seen in B type dies.
Use die holder **V816**.

mm ²	Dies	No. of crimps
31-62	B16NP	2x5
99	8B20NP	2x10



BNP dies, die holder V816.

For oval crimping of earth conductor branch connector (C-sleeves).
Use die holder **V816**.

Through (main) conductor, mm ²	Branch mm ²	Dies	No. of crimps
10-6	10-6	BC4*	1
16-10	16-10	8BC5	1
25-16	25-16	8BC6	1
50-16	50-16	8BC8-9	2
70-50	70-25	8BC11	2

*Die nest marked C4A is used for 6 mm² main to 6 mm² branch.

9



BC die, die holder V816.

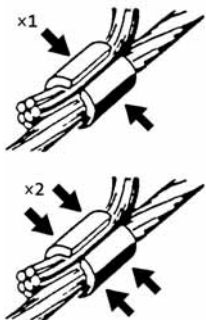

One resp. two crimps on C-sleeves.

Accessories for Al crimping, see next page.



Accessories for crimping Al terminals and connectors with V800

- When crimping Al terminals and connectors, two indent crimps are always made, see picture.

Punch and matrix

Indent crimping of Al terminals and connectors.

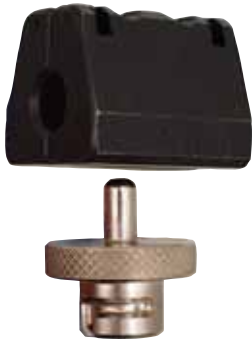

Matrix P13M and punch P13D.

Stranded mm ²	Solid mm ²	Matrix	Punch
16	16 (+25)	P13M	P13D
25	35	P13M	P13D
35	50	P20M	P20D
50	70	P20M	P20D
70	95	P20M	P20D
95	120	P25M	P25D
120	150	P25M	P25D
150	185	P25M	P25D

* Always make two crimps on Al as in picture.



Crimp sequence.



Pre-rounding matrix R13MR and punch R13DR.

Pre-rounding of sector shaped Al conductors.

Stranded mm ²	Solid mm ²	Matrix	Punch
16	16 (+25)	R6MR	13R6DR
25	35	R7MR	13R7DR
35	50	R8MR	13R8DR
50	70	R9MR	13R9DR
70	95	R12MR	13R12DR
95	120	R13MR	13R13DR
120	150	R15MR	13R15DR
150	185	R16MR	13R16DR



SYSTEM 1300 for Cu terminals and connectors 10 - 400 mm², Cu C-sleeves 6 - 120 mm² and Al terminals and connectors 16 - 240 mm²

V1300



Crimp types



V1300

Elpress crimp head, used with footpump P4000 or battery / mains powered pump P5700.

Particulars:

- equipped with oil spray safety protection cap
- working pressure 63 MPa (630 bar)
- weight 3,7 kg, excl. accessories
- length 270 mm, incl. quick coupling, width 82 mm
- crimp force 130 kN (13 tons)
- light and flexible steel crimp head
- special nitrogen anti-corrosion surface treatment

V1300TI



Crimp types



V1300TI

Titanium version of the above V1300-head.

Particulars:

- weight 2,1 kg, excl. accessories

9

V1311



Crimp types



V1311

This Elpress hydraulic handtool uses the same accessories as for V1300 above.

Particulars:

- automatic fast forward action
- supplied with carry box, see page 9:18
- crimp force 130 kN (13 tons)
- requires low hand force, about 245 N at max. force
- length 590 mm
- weight 4.9 kg, excl. accessories



PV1300



Crimp types



PV1300

Battery powered crimp tool with 13 tons force. Uses the same crimp accessories as the other products in the above V1300 System.

Particulars:

- crimps copper conductors up to 400 mm²
- crimps aluminium conductors up to 240 mm²
- crimps C-sleeves up to 120/120 mm²
- crimp force 123 kN (13 ton)
- number of crimps: 30-80 depending on size and temperature
- crimp time: 12-18 s depending on size
- environmental friendly battery NiMH-type, 12 V, 2.6 Ah
- working temperature -20°C to +40° (battery: +5°C to +40°C)
- LED indication of charge status
- supplied with robust double shell plastic case, battery, charger and instruction
- weight 5,1 kg, (incl. battery)



Accessories for crimping Cu with V1300(TI), V1311 and PV1300

Crimp dies

Supplied as a pair. For hexagonal crimping of Cu terminals and connectors.
If not indicated otherwise, always use inner die holder V1316 and outer die holder V1318.



V1318 + B type dies + V1316.

KRF/KSF		
mm ²	Dies	No. of crimps
10	B8	1
16	B9	1
25	B11	1
35	B13	1
50	B14,5	1
70	B17	1
95	B20	1
120	B22	1
150	B25	1
185	13B27*	2
240	13B30*	2
300	13B32*	2
400	13B38*	3

* All dies **type 13Bxx** are used **without die holder**.

KRD/KSD		
mm ²	Dies	No. of crimps
10	B8	1
16	B8	1
25	B9	1
35	B11	1
50	B12	1
70	B14	1
95	B16	1
120	B19	1
150	B22	1
185	13B25*	2
240	13B27*	2
300	13B30*	2
400	13B32*	2

* All dies **type 13Bxx** are used **without die holder**.

KRT/KST		
mm ²	Dies	No. of crimps
10	B7	1
16	B8.5	1
25	B10	1
35	B12	1
50	B14	1
70	B16	1
95	B18	1
120	B19	1
150	B22	1
185	B24	1
240	13B26*	2
300	13B30*	2
400	13B32*	2

* All dies **type 13Bxx** are used **without die holder**.

9

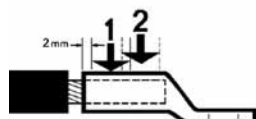
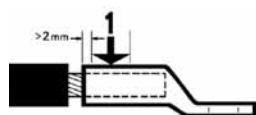

Two crimps.

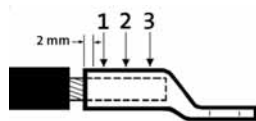

Three crimps.



DIN 46235		
mm ²	Dies	No. of crimps
10	B6DIN	1
16	B8DIN	1
25	B10DIN	1
35	B12DIN	1
50	B14DIN	1
70	B16DIN	1
95	B18DIN	1
120	B20DIN	1
150	B22DIN	1
185	13B25DIN*	2
240	13B28DIN*	2
300	13B32DIN*	3

* All die type **13Bxx** are used **without die holder**.

For oval crimping of Cu branch connectors (C-sleeves).

If not indicated otherwise, always use inner die holder **V1316** and outer die holder **V1318**.

Through conductor mm ²	Branch mm ²	Dies	No. of crimps
10-6	10-6	BC4**	1
16-10	16-10	BC5	1
25-16	25-16	BC6	1
50-16	50-16	BC8-9	1
70-50	70-25	BC11	1
95-70	95-25	13BC13*	2
120-95	120-25	13BC15*	2

* Are used without die holders; make two crimps, see picture.

** Die nest must be marked C4A to connect 6 mm² main to 6 mm² branch.



V1318 + BC type dies + V1316.

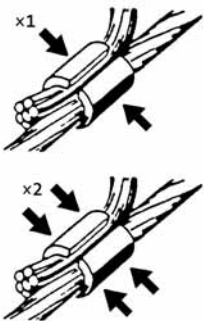

One or two crimps made.



Accessories for crimping Al with V1300(TI), V1311 and PV1300

■ When crimping Al terminals and connectors, two indent crimps are always made, see picture.

Punch and matrix

For indent crimping of Al terminals and connectors.

For 16 - 150 (185 solid) mm², matrix holder V1320 is used.



Stranded mm ²	Solid mm ²	Matrix	Punch
16	16(+25)	P13M	P13D
25	35	P13M	P13D
35	50	P20M	P20D
50	70	P20M	P20D
70	95	P20M	P20D
95	120	P25M	P25D
120	150	P25M	P25D
150	185	P25M	P25D
185	240	13P32M*	P32D
240		13P32M*	P32D

* Used without matrix holder.

Always make two crimps, see picture.



Crimp sequence.

9

V1320 matrix holder + P13M matrix + P13D punch.



For preforming of sector shaped Al conductors.

For 16 - 240 mm², matrix holder V1320 is used.

Stranded mm ²	Solid mm ²	Matrix	Punch
16	16(+25)	R6MR	13R6DR
25	35	R7MR	13R7DR
35	50	R8MR	13R8DR
50	70	R9MR	13R9DR
70	95	R12MR	13R12DR
95	120	R13MR	13R13DR
120	150	R15MR	13R15DR
150	185	R16MR	13R16DR
185	240	13R18MR	13R18DR
240		13R20MR	13R20DR

V1320 die holder + R6MR rounding matrix + 13R6DR rounding punch.



Accessories for crimping overhead line connectors with V1300(TI), V1311 and PV1300

■ For number of crimps on overhead connectors, see tables below.

Crimp dies

Supplied as a pair.

For hexagonal crimping of connectors for overhead conductors of AlMgSi (Super B) and Al 59.



mm ²	Inner die holder	Outer die holder	Dies	No. of crimps
31-62	V1316	V1318	B16NP	2x5
99	V1316	V1318	B20NP	2x5
157			13B26*	2x8
241			13B32*	2x8

* Used without die holders.

Supplied as a pair.

For hexagonal crimping of connectors for overhead ACSR conductors.

Die holders **V1316** and **V1318** to be used.

mm ²	Steel connector (inner)		Al-connector (outer)	
	Dies	No. of crimps	Dies	No. of crimps
62	B6FE	2x5	B16NP	2x5
99	B8FE	2x5	B20NP	2x5

V1318 outer die holder + BNP type dies + V1316 inner die holder.

Storage box LV1300A

Elpress carry box for the V1300(TI)- and V1311-systems.

Particulars:

- steel reinforced plywood
- polyethylen insert material
- takes matrixes, punches and dies up to 400 mm² Cu and 240 mm² Al
- weight 4.2 kg, excl. accessories
- length 465 mm, width 275 mm, height 190 mm
- the box can be used as storage or be taken to site
- sturdy, form cut inserts



Storage box LV1300A for the 1300-system.





C-type crimp head for Cu 10 - 400 mm² (KRF 300 mm²)

V1300C



Crimp types



V1300C

Elpress crimp head, used with footpump P4000 or battery / mains powered electrohydraulic pump P5700.

Particulars:

- equipped with oil spray safety protection cap
- working pressure 63 MPa (630 bar)
- crimp force 130 kN
- flexible and easy to operate
- covers the common needs of Cu-crimping in utilities
- tested together with Elpress pumps and terminals
- length 295 mm, incl fork and quick coupling, width 145 mm
- weight 4.2 kg, excl accessories

V1311C



Crimp types



V1311C

Elpress hydraulic handtool used with the same die system as V1300C above.

Particulars:

- automatic two-step fast feed system
- full closure system which guarantees a complete crimp
- the fork is rotatable 180°
- weight 6.4 kg, excl accessories
- length 620 mm
- crimp force 130 kN
- ergonomically shaped handles
- easy to carry and operate
- covers the common needs of Cu-crimping for electricity utilities
- carry box

9



Carry box supplied with V1311 and V1311C.



Accessories for Cu crimping with V1300C and V1311C

■ Die holder V1330 is designed to allow crimping of straight as well as angular terminals.

Crimp dies

Supplied as a pair.

For hexagonal crimping of Cu terminals.

If not otherwise indicated, use **die holder V1330**.



Die holders V1330 (pair).



B type dies.

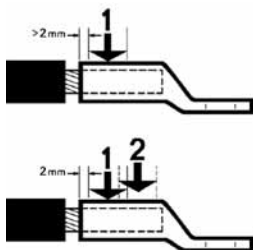

Two crimps.

KRF/KSF		
mm ²	Dies	No. of crimps
10	B8	1
16	B9	1
25	B11	1
35	B13	1
50	B14,5	1
70	B17	1
95	B20	1
120	B22	1
150	B25	1
185	13CB27*	2
240	13CB30*	2
300	13CB32*	2

* All dies type **13Bxx** are used **without die holders**.

KRD/KSD		
mm ²	Dies	No. of crimps
10	B8	1
16	B8	1
25	B9	1
35	B11	1
50	B12	1
70	B14	1
95	B16	1
120	B19	1
150	B22	1
185	13CB25*	2
240	13CB27*	2
300	13CB30*	2
400	13CB32*	2

* All dies type **13Bxx** are used **without die holders**.

KRT/KST		
mm ²	Dies	No. of crimps
10	B7	1
16	B8,5	1
25	B10	1
35	B12	1
50	B14	1
70	B16	1
95	B18	1
120	B19	1
150	B22	1
185	13CB24*	2
240	13CB26*	2
300	13CB30*	2
400	13CB32*	2

* All dies type **13Bxx** are used **without die holders**.





DIN 46235		
mm ²	Dies	No. of crimps
10	B6DIN	1
16	B8DIN	1
25	B10DIN	1
35	B12DIN	1
50	B14DIN	1
70	B16DIN	1
95	B18DIN	1
120	B20DIN	1
150	B22DIN	1

For oval crimping of Cu branch connectors (C-sleeves).
If not otherwise indicated, use die holder **V1330**.

Main conductor mm ²	Branch mm ²	Dies	No. of crimps
10-6	10-6	BC4**	1
16-10	16-10	BC5	1
25-16	25-16	BC6	1
50-16	50-16	BC8-9	1
70-50	70-25	BC11	1
95-70	95-25	13CBC13*	2

* Are used without die holders.

** Die nest must be marked C4A to connect 6 mm² main to 6 mm² branch.



BC type dies.

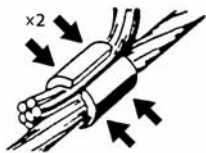
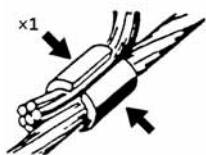

One or two crimps.



DUAL SYSTEM for crimping flexible conductors in KRF/KSF-connectors for demanding applications, 16 - 300 mm²



DV1300



Crimp geometries



DUAL+regular crimps

DV1300

Crimp head for use with footpump P4000 or battery / mains powered pump PS700.

Particulars:

- crimp head with the patented DUAL CRIMP technique which starts with an optimized hexagonal crimp and then makes a small indent in the same crimp cycle to further improve gas tightness as well as electrical and mechanical properties
- DUAL dies are available for 16 - 300 mm²
- crimps terminals type KRF and through connectors type KSF
- conventional accessories as shown for V1300 can be used (without DUAL-function)
- no die holders are necessary when using DUAL dies
- weight 3.4 kg
- DV1300 can also be used with regular crimp dies for the 1300-system

DV1300C

C-fork type crimp head, open to one side, for use with footpump P4000 or mains and battery pump PS700.

Particulars:

- Crimp head with the patented DUAL CRIMP technique which starts with an optimized hexagonal crimp and then makes a small indent in the same crimp cycle to further improve gas tightness as well as electrical and mechanical properties
- DUAL dies are available for 16 - 300 mm²
- crimps terminals type KRF and through connectors type KSF
- conventional dies as for V1300C can be used (without DUAL-function)
- no die holders are necessary when using DUAL-dies
- weight 4,9 kg
- DV1300C can also be used with regular crimp dies for the 1300C-system

DV1300C



Crimp geometries



The DUAL System Technology is patented by Elpress. Accessories, see next page.





Accessories for crimping flexible Cu conductors in the DUAL Crimp system DV1300 and DV1300C

DUAL crimp dies

Supplied in pairs.

For crimping of flexible Cu conductors in terminals type KRF or connectors type KSF.

No die holders necessary.



Die pair 13DB20.



Die pair 13DCB20.

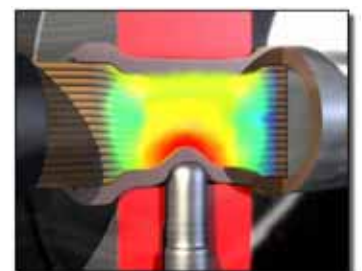
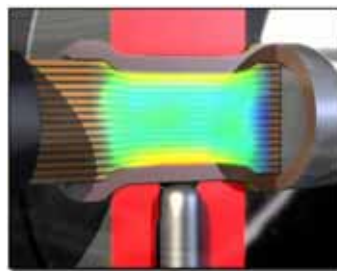
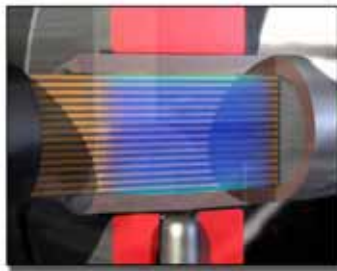

mm ²	Dies for DV1300	Dies for DV1300C	No. of crimps
16	13DB9	13DCB9	1
25	13DB11	13DCB11	1
35	13DB13	13DCB13	1
50	13DB14,5	13DCB14,5	1
70	13DB17	13DCB17	1
95	13DB20	13DCB20	1
120	13DB22	13DCB22	2
150	13DB25	13DCB25	2
185	13DB27	13DCB27	2
240	13DB30	13DCB31	2
300	13DB32	13DCB32	2



SYSTEM V250 for crimping Cu terminals and connectors 10 - 800 mm², C-sleeves up to 300 mm² and Al terminals and connectors 16 - 630 mm²

V250



Crimp types



V250

Crimp head used together with footpump P4000 or battery / mains powered pump PS700.

Particulars:

- equipped with oil spray safety protection cap
- working pressure 63 MPa (630 bar)
- crimp force 250 kN (25 ton)
- crimp terminals and connectors of type KRF/KSF, KRT/KST, KR D/KSD for Cu-conductors up to 800 mm²
- crimp terminals and connectors of Al-conductors up to 630 mm²
- crimp Cu-branch connectors (C-sleeves) up to 300 mm²
- uses nearly all the same crimp dies as the 1400-system and 2500-system
- tested with Elpress pumps and connectors
- weight 4.6 kg, excl. accessories
- dimensions Ø 111 mm x 280 mm



Accessories for crimping Cu with V250

- Terminals and connectors of type KRF/KSF are designed for both stranded and flexible Cu-conductors of class 2 and 5 according to SS-IEC 60228, and terminals and connectors of type KRK/KSK and KRT/KST are designed for stranded Cu-conductors, class 2.

Crimp dies

Supplied in pairs.

For hexagonal crimping of Cu terminals and connectors.



Die holder V2508, B-dies, Die holder V2506.



Die pair B2542, used without die holder.

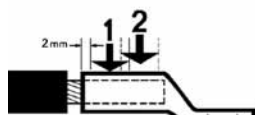
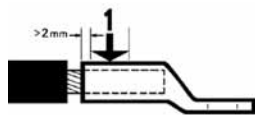

Two crimps overlapping.

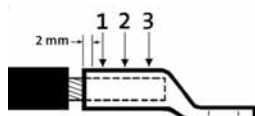

Three crimps.

KRF/KSF				
mm ²	Die holder	Die holder	Dies for	No. of crimps
10	V2506	V2508	B8	1
16	V2506	V2508	B9	1
25	V2506	V2508	B11	1
35	V2506	V2508	B13	1
50	V2506	V2508	B14,5	1
70	V2506	V2508	B17	1
95	V2506	V2508	B20	1
120	V2506	V2508	B22	1
150	V2506	V2508	B25	1
185	V2506	V2508	B27	1
240	V2506	V2508	B30	1
300	V2506	V2508	B32	1
400			B2538*	2
500			B2542*	2
630			B2553*	3
800			B2553*	3

* Used without die holders.

KRT/KST				
mm ²	Die holder	Die holder	Dies for	No. of crimps
10	V2506	V2508	B7	1
16	V2506	V2508	B8,5	1
25	V2506	V2508	B10	1
35	V2506	V2508	B12	1
50	V2506	V2508	B14	1
70	V2506	V2508	B16	1
95	V2506	V2508	B18	1
120	V2506	V2508	B19	1
150	V2506	V2508	B22	1
185	V2506	V2508	B24	1
240	V2506	V2508	B26	1
300	V2506	V2508	B30	1
400	V2506	V2508	B32	1
500			B2540*	2
630			B2545*	3
800			B2553*	3

* Used without die holders.



KRD/KSD				
mm ²	Die holder	Die holder	KRD/KSD	No. of crimps
10	V2506	V2508	B8	1
16	V2506	V2508	B8	1
25	V2506	V2508	B9	1
35	V2506	V2508	B11	1
50	V2506	V2508	B12	1
70	V2506	V2508	B14	1
95	V2506	V2508	B16	1
120	V2506	V2508	B19	1
150	V2506	V2508	B22	1
185	V2506	V2508	B25	1
240	V2506	V2508	B27	1
300	V2506	V2508	B30	1
400	V2506	V2508	B32	1
500			B2540*	2
630			B2545*	3
800			B2553*	3

* Used without die holders.

DIN46235				
mm ²	Die holder	Die holder	DIN46235 dies	No. of crimps
10	V2506	V2508	B6DIN	1
16	V2506	V2508	B8DIN	1
25	V2506	V2508	B10DIN	1
35	V2506	V2508	B12DIN	1
50	V2506	V2508	B14DIN	1
70	V2506	V2508	B16DIN	1
95	V2506	V2508	B18DIN	1
120	V2506	V2508	B20DIN	1
150	V2506	V2508	B22DIN	1
185	V2506	V2508	B25DIN	2
240	V2506	V2508	B28DIN	2
300	V2506	V2508	B32DIN	3

9



Die holder V2508, BC-dies, die holder V2506.

For oval crimping of Cu branch connectors (C sleeves).

Main conductor mm ²	Branch mm ²	Die holder	Die Holder	Dies	No. of crimps
10-6	10-6	V2506	V2508	BC4*	1
16-10	16-6	V2506	V2508	BC5	1
25-16	25-16	V2506	V2508	BC6	1
50-16	50-16	V2506	V2508	BC8-9	1
70-50	70-25	V2506	V2508	BC11	1
95-70	95-25	V2506	V2508	BC13	1
120-95	120-25	V2506	V2508	BC15	1
150-120	150-35			B25C16**	1
185-150	185-35			B25C18**	2
300-240	300-35			B25C21**	2

* Die nest must be marked C4A to connect 6 mm² main to 6 mm² branch. ** Use without die holders.

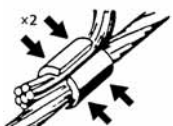
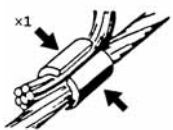

Crimp sequence.





Accessories for crimping overhead line connectors with V250



Die holder V2508, BNP-dies, die holder V2506.

Crimp dies

Supplied in pairs.

For hexagonal crimping of overhead line connectors for conductors **type AlMgSi**.

mm ²	Die holder	Die holder	Dies	No. of crimps
31-62	V2506	V2508	B16NP	2 x 5
99	V2506	V2508	B20NP	2 x 5
157	V2506	V2508	B26NP	2 x 8
241	V2506	V2508	B32NP	2 x 8

Supplied in pairs.

For hexagonal crimping of overhead line connectors for conductors **type ACSR (FeAl)**.

mm ²	Die holder	Die holder	Dies for steel sleeve	Dies for Al-sleeve	No. of crimps
62	V2506	V2508	B6FE	B16NP	2 x 5
99	V2506	V2508	B8FE	B20NP	2 x 5

Supplied in pairs.

For hexagonal crimping of overhead line connectors for conductors **type ALUS**.

mm ²	Die holder	Die holder	Dies	No. of crimps
50	V2506	V2508	B16NP	2 x 5
95	V2506	V2508	B20NP	2 x 8



Accessories for crimping Al with V250

- When indent crimping Al terminals and connectors, two indents are always made, see picture.

Punch and Matrix

For indent crimping of Al-terminals and connectors.
(no punch holder is needed)



Matrix holder V2521, matrix P13M, punch P13D.

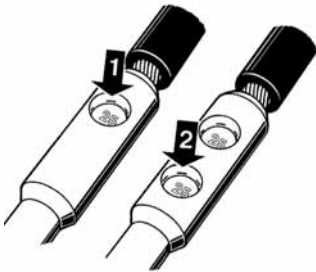

Crimp sequence.

Stranded mm ²	Solid mm ²	Matrix	Matrix holder	Punch
16	16 (+25)	P13M	V2521	P13D
25	35	P13M	V2521	P13D
35	50	P20M	V2521	P20D
50	70	P20M	V2521	P20D
70	95	P20M	V2521	P20D
95	120	P25M	V2521	P25D
120	150	P25M	V2521	P25D
150	185	P25M	V2521	P25D
185	240	P32M	V2531	P32D
240		P32M	V2531	P32D
300	300	P36M	V2531	P36/40/44D
400		P40M	V2531	P36/40/44D
500*		P44M	V2531	P36/40/44D
500**		P2552M		P2552D
630		P2552M		P2552D

* Used with terminals and connectors type AK/AS/AKK/AKS 500B

** Used with terminals and connectors type AK/AS/AKK/AKS 500A

For pre-rounding of Al sector conductors, use punch holder **V2540**.

Stranded mm ²	Solid mm ²	Matrix	Matrix holder	Punch
16	16 (+25)	R6MR	V2521	R6DR
25	35	R7MR	V2521	R7DR
35	50	R8MR	V2521	R8DR
50	70	R9MR	V2521	R9DR
70	95	R12MR	V2521	R12DR
95	120	R13MR	V2521	R13DR
120	150	R15MR	V2521	R15DR
150	185	R16MR	V2521	R16DR
185	240	R18MR	V2531	R18DR
240		R20MR	V2531	R20DR
300	300	R21MR	V2531	R21DR
400		R26MR	V2531	R26DR
500		R28MR	V2531	R28DR



SYSTEM 1400 for Cu terminals and connectors 10 - 500 mm², C-sleeves up to 150 mm² and Al terminals and connectors 16 - 630 mm²

V1400



Crimp types



V1400

Crimp head used together with footpump P4000 or battery / mains powered pump P5700.

Particulars:

- exchangeable forks
- bayonet fork fitting
- cutting accessory available, see page 9:34
- equipped with oil spray safety protection cap
- presshead V1400 is used together with forks V1411, V1421, V1431 and V1438. The forks are designed to meet highest demands on versatility and accessibility but still manage about 5000 crimps. Fork V1411I to be used when crimping large volumes of Cu-terminals.
- working pressure 63 MPa (630 bar)
- weight 3.2 kg, excl. accessories
- dimensions Ø 100 mm x 180 mm (widest part 120 mm), excl. fork
- crimp force 200 kN (20 ton)
- to be discontinued by the end of year 2005



Accessories for crimping Cu with V1400

- At large crimp volumes use fork V1411 I for very long life expectancy.

Crimp dies

Supplied in pairs.

For hexagonal crimping of Cu terminals and connectors.



Fork V1411 + B dies + die holder V1416.

KRF/KSF				
mm ²	Fork	Die holder	Dies	No. of crimps
10	V1411	V1416	B8	1
16	V1411	V1416	B9	1
25	V1411	V1416	B11	1
35	V1411	V1416	B13	1
50	V1411	V1416	B14,5	1
70	V1411	V1416	B17	1
95	V1411	V1416	B20	1
120	V1411	V1416	B22	1
150	V1411	V1416	B25	1
185	V1411	V1416	B27	2
240	V1411	V1416	B30	2
300	V1411	V1416	B32	2
400*	V1431		14B38	2
500	V1431		14B42	2
KRD500	V1431		14B40	2

* For connector type KRF400A-xx or KSF400A. for previous type KRF/KSF400 use dies B36 and V1411 fork.



Fork V1431 + die pair 14B38.

KRD/KSD				
mm ²	Fork	Die holder	Dies	No. of crimps
10	V1411	V1416	B8	1
16	V1411	V1416	B8	1
25	V1411	V1416	B9	1
35	V1411	V1416	B11	1
50	V1411	V1416	B12	1
70	V1411	V1416	B14	1
95	V1411	V1416	B16	1
120	V1411	V1416	B19	1
150	V1411	V1416	B22	1
185	V1411	V1416	B25	1
240	V1411	V1416	B27	2
300	V1411	V1416	B30	2
400	V1411	V1416	B32	2
500	V1431		14B40	2

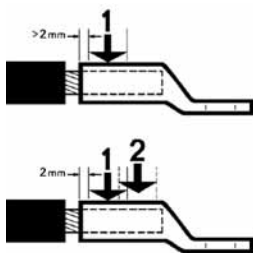

One or two crimps.



KRT/KST				
mm ²	Fork	Die holder	KRT/KST	No. of crimps
10	V1411	V1416	B7	1
16	V1411	V1416	B8.5	1
25	V1411	V1416	B10	1
35	V1411	V1416	B12	1
50	V1411	V1416	B14	1
70	V1411	V1416	B16	1
95	V1411	V1416	B18	1
120	V1411	V1416	B19	1
150	V1411	V1416	B22	1
185	V1411	V1416	B24	1
240	V1411	V1416	B26	1
300	V1411	V1416	B30	2
400	V1411	V1416	B32	2
500	V1431		14B40	2

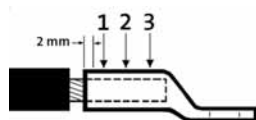

Three crimps.

DIN 46235				
mm ²	Fork	Die holder	Dies	No. of crimps
10	V1411	V1416	B6DIN	1
16	V1411	V1416	B8DIN	1
25	V1411	V1416	B10DIN	1
35	V1411	V1416	B12DIN	1
50	V1411	V1416	B14DIN	1
70	V1411	V1416	B16DIN	1
95	V1411	V1416	B18DIN	1
120	V1411	V1416	B20DIN	1
150	V1411	V1416	B22DIN	1
185	V1411	V1416	B25DIN	2
240	V1411	V1416	B28DIN	2
300	V1411	V1416	B32DIN	3





For oval crimping of Cu branch connectors (C sleeves).



Through connector, mm ²	Branch mm ²	Fork	Die holder	Dies	No. of crimps
10-6	10-6	V1411	V1416	BC4*	1
16-10	16-10	V1411	V1416	BC5	1
25-16	25-16	V1411	V1416	BC6	1
50-16	50-16	V1411	V1416	BC8-9	1
70-50	70-25	V1411	V1416	BC11	1
95-70	95-25	V1411	V1416	BC13	1
120-95	120-25	V1411	V1416	BC15	1
150-120	150-35	V1411	V1416	BC16	2

* Die nest must be marked C4A to connect 6 mm² main to 6 mm² branch.

Fork V1411 + BC type dies + die holder V1416.

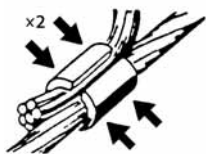
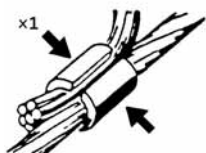

One or two crimps.



Accessories for crimping overhead line connectors with V1400

Crimp dies

Supplied in pairs.

For hexagonal crimping of overhead line connectors for conductors **type AC** (Al-alloy).

For all dies below use fork **V1411** and die holder **V1416**.



mm ²	Dies	No. of crimps
31-62	B16NP	2x5
99	B20NP	2x5
157	B26NP	2x8
241	B32NP	2x8

Supplied in pairs.

For hexagonal crimping of overhead line connectors for conductors **type ACSR** (FeAl).

For all dies below use fork **V1411** and die holder **V1416**.

mm ²	Steel connector (inner)		Al-connector (outer)	
	Dies	No. of crimps	Dies	No. of crimps
62	B6FE	2x5	B16NP	2x5
99	B8FE	2x5	B20NP	2x5

Fork V1411 + BNP type dies + die holder V1416.

Fork for industrial use V14111

Elpress industrial fork, used as an alternative to fork V 1411 when crimping large numbers of terminal lugs.

Particulars:

- high life expectancy
- designed for frequent use, e.g. by wiring harness manufacture
- weight 2,9 kg

V14111





Accessories for crimping Al with V1400

- When indent crimping Al terminals and connectors, two indent crimps are always made, see picture.

Punch and Matrix

For indent crimping of Al-terminals and connectors.
Use punch holder V1440.



Fork V1421 + matrix P13M + punch P13D + punch holder V1440.

Stranded mm ²	Solid mm ²	Fork	Matrix	Punch
16	16 (+25)	V1421	P13M	P13D
25	35	V1421	P13M	P13D
35	50	V1421	P20M	P20D
50	70	V1421	P20M	P20D
70	95	V1421	P20M	P20D
95	120	V1421	P25M	P25D
120	150	V1421	P25M	P25D
150	185	V1421	P25M	P25D
185	240	V1431	P32M	P32D
240		V1431	P32M	P32D
300	300	V1431	P36M	P36/40/44D
400		V1431	P40M	P36/40/44D
500		V1438	P44M	P36/40/44D
alt. 500		V1438	P52M	P52D
630		V1438	P52M	P52D

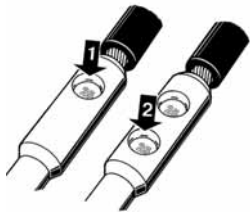

Crimp sequence.

For pre-rounding of Al sector conductors.
Use punch holder V1440.



Fork V1421 + rounding matrix R6MR + rounding die R6DR + die holder V1440.

Stranded mm ²	Solid mm ²	Fork	Matrix	Punch
16	16 (+25)	V1421	R6MR	R6DR
25	35	V1421	R7MR	R7DR
35	50	V1421	R8MR	R8DR
50	70	V1421	R9MR	R9DR
70	95	V1421	R12MR	R12DR
95	120	V1421	R13MR	R13DR
120	150	V1421	R15MR	R15DR
150	185	V1421	R16MR	R16DR
185	240	V1431	R18MR	R18DR
240		V1431	R20MR	R20DR
300	300	V1431	R21MR	R21DR
400		V1431	R26MR	R26DR
500		V1431	R28MR	R28DR



Cutting accessories for V1400

KL1485



KL1485

Cable cutter.

Particulars:

- used together with crimp head V1400
- cuts up to 4 x 150 mm² Cu conductors and Ø 85 mm Al-, paper- and plastic-insulated cables, (there might be limitations due to material and design of the cable)
- also cuts steel armoured cables, but not steel wire armoured cables
- weight 7.9 kg
- dimensions 275 x 260 mm
- supplied in a plywood box, weight 3,5 kg

BKL30



BKL30

Cutting dies.

Particulars:

- used together with fork V1431 and crimp head V1400
- cuts cables and conductors except for steel wired armoured up to 30 mm outer diameter
- weight 0.90 kg/pair
- dimensions lower part 69 x 59,5 mm
- dimensions upper part 50 x 69 mm

9

Storage box LV1400A

Elpress storage box for the V1400 System accessories.

Particulars:

- material plywood, inserts from polyethylene
- takes forks, matrices, punches and dies
- weight 4.8 kg, excl. accessories
- dimensions 670 x 275 x 190 mm



Storage box LV1400A for the 1400-system.



Tool for Cu terminals and connectors 500 - 1000 mm², C sleeves 185 - 300 mm² and Al terminals and connectors 800 - 1200 mm²

V1470

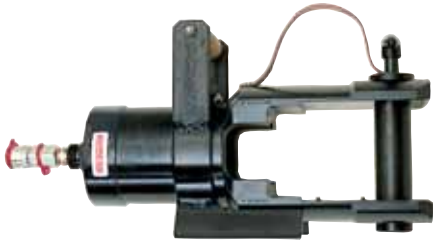

Crimp types



V1470

Elpress crimp head, used together with foot pump P4000 or battery / mains powered electro hydraulic pump PS700.

Particulars:

- equipped with oil spray safety protection cap
- working pressure 63 MPa (630 bar)
- weight 21.5 kg (incl box 28.5 kg)
- length 510 mm, width 235 mm
- crimp force 400 kN
- supplied in a rigid plywood box



Accessories for crimping Cu and Al with V1470

- **Two crimps/indents** are made when crimping Cu terminals 500 - 1000 mm², and Al terminals 800 - 1200 mm².
- For Cu branch connectors only **one crimp** is made.

Crimp dies

Supplied in pairs.
For hexagonal crimping of Cu terminals and connectors.



B4040 dies.

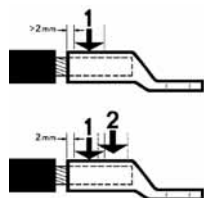

Two crimps.

mm ²	Cable type/Terminal or connector type	Dies	No. of crimps
500	Stranded/KRD/KSD/KRT/KST	B4040	2
500	Flexible/KRF/KSF	B4042	2
630	Stranded/KRD/KSD/KRT/KST	B4045	2
630	Flexible/KRF/KSF	B4053	2
800	Stranded/KRD/KSD/KRT/KST	B4053	2
800	Flexible/KRF/KSF	B4053	2
1000	Stranded/KRD/KSD/KRT/KST	B4056	2

For oval crimping of branch connectors (C sleeves).

Main conductor, mm ²	Branch, mm ²	Dies	No. of crimps
185-150	185-35	B40C18	1
300-240	300-35	B40C21	1

9



B40C18 dies.

Punch and Matrix

For indent crimping of Al terminals and connectors.

Stranded, mm ²	Matrix holder	Matrix	Punch
800	V1471	W60M	W60D
1000	V1471	W60M	W60D
1200	V1471	W70M	W70D

Always make two crimps on Al.



Matrix holder V1471 + matrix W60M + punch W60D.



Crimp sequence.



Hydraulic foot pump

This pump operates all Elpress crimp heads.

P4000

Elpress hydraulic footpump.

P4000



Particulars:

- unique design in high tensile aluminium alloy
- low weight, 8.6 kg, incl. 2.2 m hose
- standard setting 630 bar (max setting to 700 bar)
- safety valve for relief at all pressures
- a pressure gauge can be attached to indicate working pressure
- ergonomic design
- high finish anodised surface - easy to keep clean
- high efficiency two-step oil flow
- simple foot operated off-loading (piston return) after automatic stop at full pressure
- robust and stable to work with
- practical storage position for hose



Battery and mains powered pump

The pump operates all Elpress crimp heads.

PS700

PS700



Battery and mains powered pump for crimping with advanced control and supervision of the crimp procedure.

A flexible system for almost all crimp applications where high performance and reliability is required. The robust design in aluminium, combined with a high total efficiency, allows intensive use in most cases and environments.

When battery powered, the upper unit is lifted off the lower mains drive unit for full flexibility.

Particulars:

- 24 V NiMH battery or 230 V mains power supply (110V optional)
- high efficiency = many crimps per charge
- close to continuous work when mains powered
- working pressures up to 700 bar / 70MPa / 10 000 PSI
- LCD display for versatile control and follow-up
- PC port for transferring data to PC computer where advanced analysis can be made
- hydraulic pressure work range 0-630 (700) bar
- hydraulic flow 0.6 dm³/min
- oil volume 1.0 dm³
- measures: pump unit, w x d x h = 390 x 225 x 225 mm
- mains unit, w x d x h = 495 x 300 x 660 (980) mm
- weight pump unit 12.3 kg (incl. battery, excl. hose)
- weight mains unit with carriage 8.6 kg
- battery fast charger 7.2-24V, charge time 45 min
- mains unit: in 230VAC, out 24-28VDC 30A; overvoltage and overcurrent protected
- control system: Elpress Advanced Crimp Analyzer incl. display and control switches. Port for PC-connection
- environment temperatures -15 °C to + 40 °C; battery to be kept >5 °C for best power
- typical number of crimps per charge (50 % ED): 115 Cu-terminals 150 mm² flexible, 180 Cu-terminals 50 mm² flexible (depending on temperature)
- protection class IP 54
- CE-approved; Machine Safety 98/37/CE, LVD 72/23/EEC



Analyzer PS700

The special software is used to save data for important documentation. In a simple way crimping can be analyzed in a PC. Every crimp-cycle receives a unique ID-number. With the help of the comfortable solution to convert data to Excel, a lot of opportunities for quality control comes up. For example to compare crimping graphs, to detect divergences and system control.

Analyzer PS700: CD with program, instructions and all cables etc. to connect between PS700 and PC.

Particulars:

- transfer data from PS700 to PC (RS232 or USB)
- save data in PC
- direct examination at display print
- easy to convert data to Excel
- for more advanced analyzes a pre-knowledge in Excel is necessary
- compatible Windows 95, 98, 2000 and XP



Analyzer PS700, special software for crimp data.